



Industrial Bolting Catalog
Air Tools, Cordless Tools and Accessories





The name says it all. Productivity has come a long way since Ingersoll Rand introduced the first impact wrench in 1934. What has not changed is our reputation for world-class tools that set the industry standard for power, durability, and reliability. Every Impactool bearing the Ingersoll Rand name reflects our commitment to delivering cutting-edge tool designs that work as hard as you do and provide maximum comfort, safety, efficiency, and serviceability. Throughout this catalog, you will find Ingersoll Rand Impactools offering several different impact technologies to best suit your wide range of applications.



Performance Classifications

SUPER-DUTY TOOLS are designed to tackle the most extreme jobs. Advanced technology gives these tools superior strength and durability across the widest range of applications.

HEAVY-DUTY TOOLS are top-quality models that exceed the requirements of highly demanding applications and environments. They are engineered with special features for top power, speed control, accuracy, and comfort.

MAINTENANCE-DUTY TOOLS are durable, high-quality, impressively powerful, and have added features for frequent or rigorous applications.

Air Impact Mechanisms

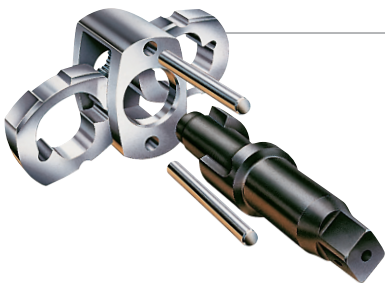

TWIN HAMMER design delivers more power per pound and is less sensitive to air pressure fluctuations than any other type of impact mechanism. This Ingersoll Rand technology has become the industry standard and is suitable for hard or soft-draw applications.

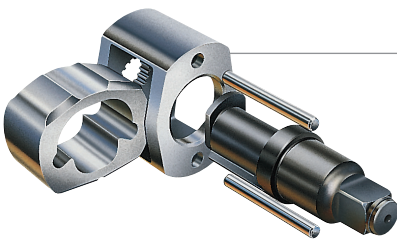

JUMBO HAMMER performs similarly to the Twin Hammer, but employs a single hammer.

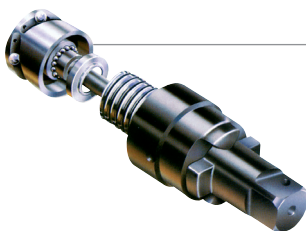

BALL AND CAM mechanisms are ideal for soft-draw applications, and are commonly used in larger Impacttools







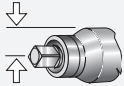
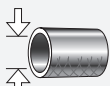
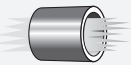
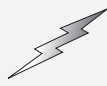

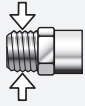
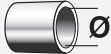





Table of Contents



Product Overview	3-5
Air Impact Wrenches	6-21
Maintenance-Duty	12-13
MAX Series	12
2100 Series.....	13
1700 Series.....	13
261 Series.....	13
Heavy-Duty	14-16
1702 Series.....	14
2900 Series.....	14
2700 Series.....	14
1720 Series.....	15
2920 Series.....	15
2934 Series.....	16
2940 Series.....	16
2950 Series.....	16
Super-Duty	17-19
2925Ti Series.....	17
3940Ti Series.....	17
3942Ti Series.....	18
3955Ti Series.....	19
5000 Series.....	19
ATEX Tools	20-21
2925TBP1TiEX.....	21
3900 Series.....	21
Cordless Impact Wrenches	22-25
IQ ^{V20} Series™	24-25
W5133.....	24
W7152.....	24
QX Series™ Cordless Torque Multiplier	26-27
QXM Pistol.....	27
QXM Angle Wrench.....	27
Accessories	28-35
Sockets & Accessories	29-31
PowerSockets® ½" Drives.....	29-30
Impact Sockets ¾"-¾" Drives.....	31
Impact Sockets 1"-2½" Drives.....	31
Filters, Regulators & Lubricators	32
Spring Balancers	33
Impact Service Kits & Hangers.....	34-35

Technical Symbols

For ease of use, specification tables frequently use symbols in column headings. Please reference the chart below for exact descriptions.

Impact Wrenches					
					
Max. Air Consumption	Blows Per Minute	Max. Torque	Torque Range	Tool Weight	Tool Length
					
Side-to-Center Distance	Minimum Hose Distance	Air Consumption @ Load	Voltage	Communication	Vibration Level
Accessories					
					
NPT Size	Hose Inner Diameter	Hose Length	Hose Outer Diameter		
					
Max. Working Pressure	Lift	Capacity	Retaining Ring		

Impact Wrench Profiles

Our impact wrenches are available with different handles to match your application. Our largest air tools (1 1/2" and larger) are also available with a T-handle.

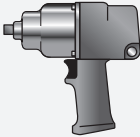
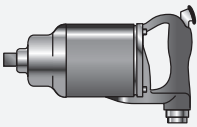
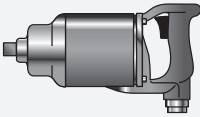
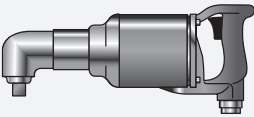
Profiles			
			
Pistol	D-Handle, Outside Trigger	D-Handle, Inside Trigger	90° angle

Air Impact Wrenches



The Hardest Hitting Impact Wrenches in the Business.

We offer a wide range of pneumatic impact wrenches that deliver the flexibility you need to fit even the most unique and demanding applications. Whether it's light routine repair work, or heavy-duty maintenance, Ingersoll Rand has the right tool for the job.

Our impact wrenches are designed with durability in mind, from the vanes turning the motor to the hammer frames and anvils. Proprietary hardening and treatment processes, innovative ergonomic designs, and excellence in manufacturing all add up to the longest lasting, hardest hitting impact wrenches in the business.

Industrial Bolting - Torque Ranges (ft-lb)

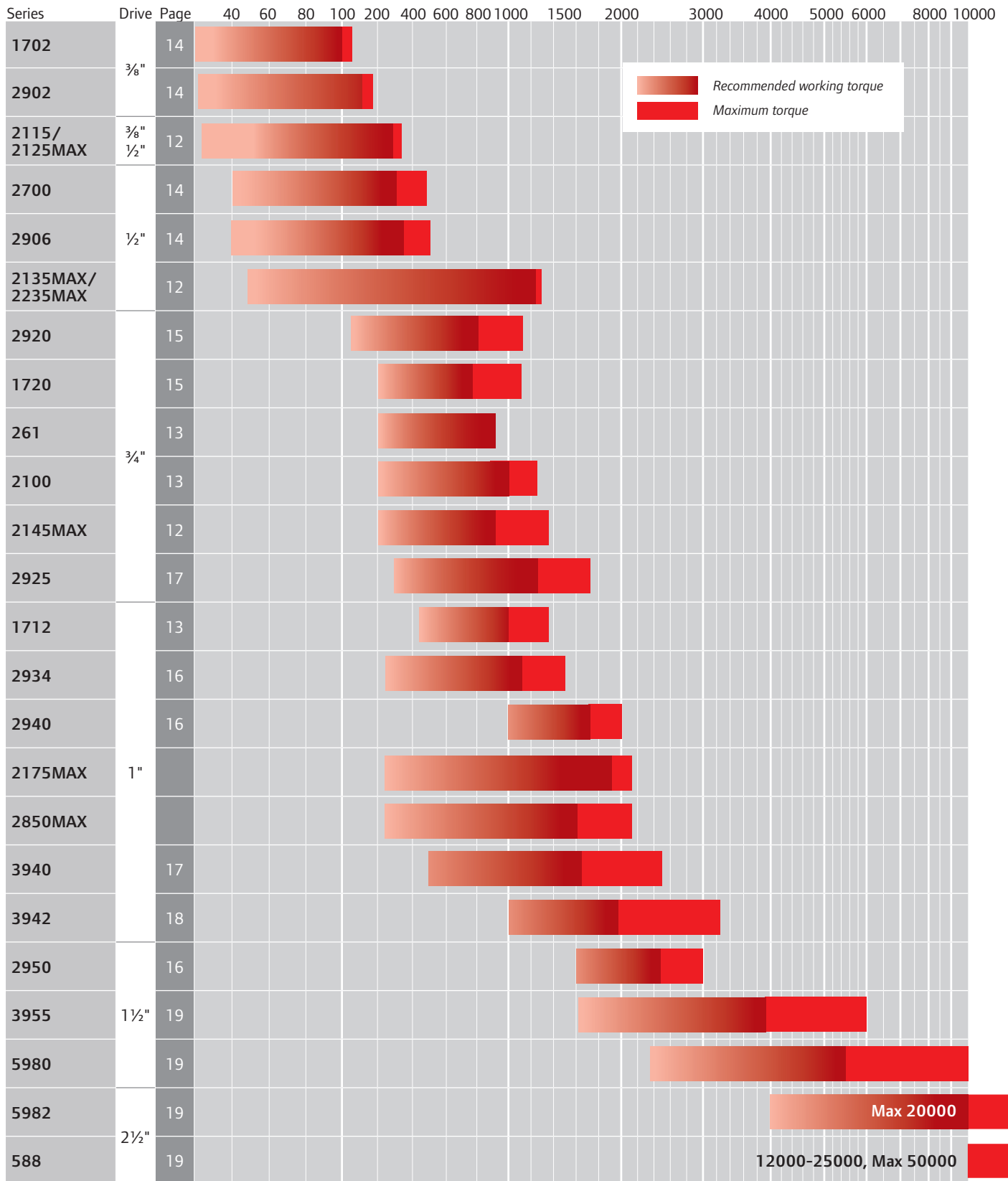

Maximum Impact

Don't settle for less. Ingersoll Rand air impact wrenches are highly regarded by professionals everywhere. They are built to last and designed to withstand tough use in rugged industrial environments.

Performance:

- Advanced engineered tools provide excellent power-to weight ratios for the performance you need for the toughest jobs

Durability:

- Robust metal housings that protect against breakage and corrosion, along with outstanding quality will maximize your productivity for the life of your tool

Comfort:

- Compact profiles and innovative ergonomic designs help minimize fatigue, making these tools easier to handle

Maintenance Duty

2145QiMax (shown below)



Heavy-Duty
2705P1 (shown below)

Steel hammer case provides increased durability for heavy-duty projects

Twin hammer impact mechanism ensures consistent power and minimizes tool vibration

Cast aluminum housing provides enhanced durability

Pressure-fed lubrication mechanism ensures complete coverage throughout the tool

Easy-to-hold pistol grip allows for increased operator control



Super-Duty
3940B2Ti (shown below)

Titanium hammer case and metal housing stand up to harsh conditions

Twin hammer impact mechanism ensures consistent power and minimizes tool vibration

Pressure-fed lubrication mechanism ensures complete coverage throughout the tool

Reverse bias motor to help remove stubborn bolts

Corrosion-resistant bronze endplates extends the life of the motor

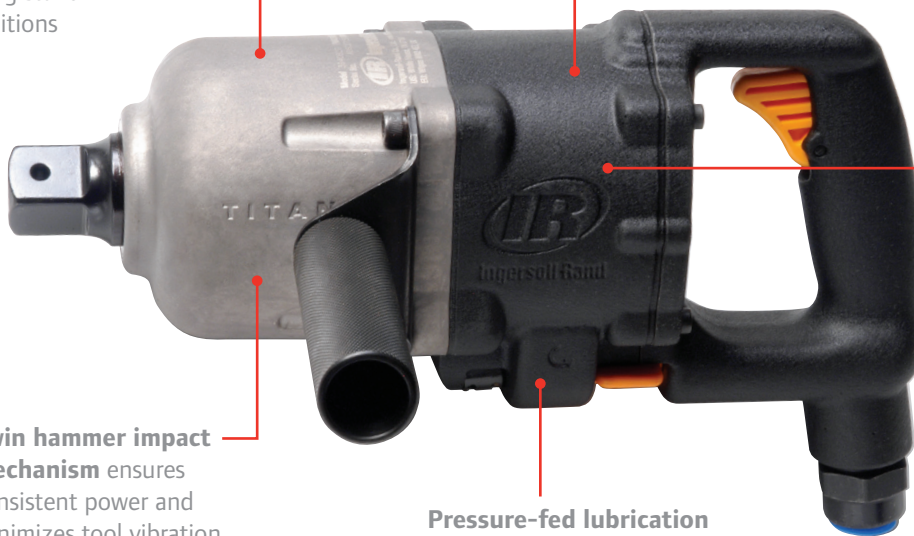

Impact Wrench Selection Guide

These charts will assist you in selecting a particular Impact wrench for a specific application. The data provided is based on 70 percent of the tension proof load of a given size and bolt grade.

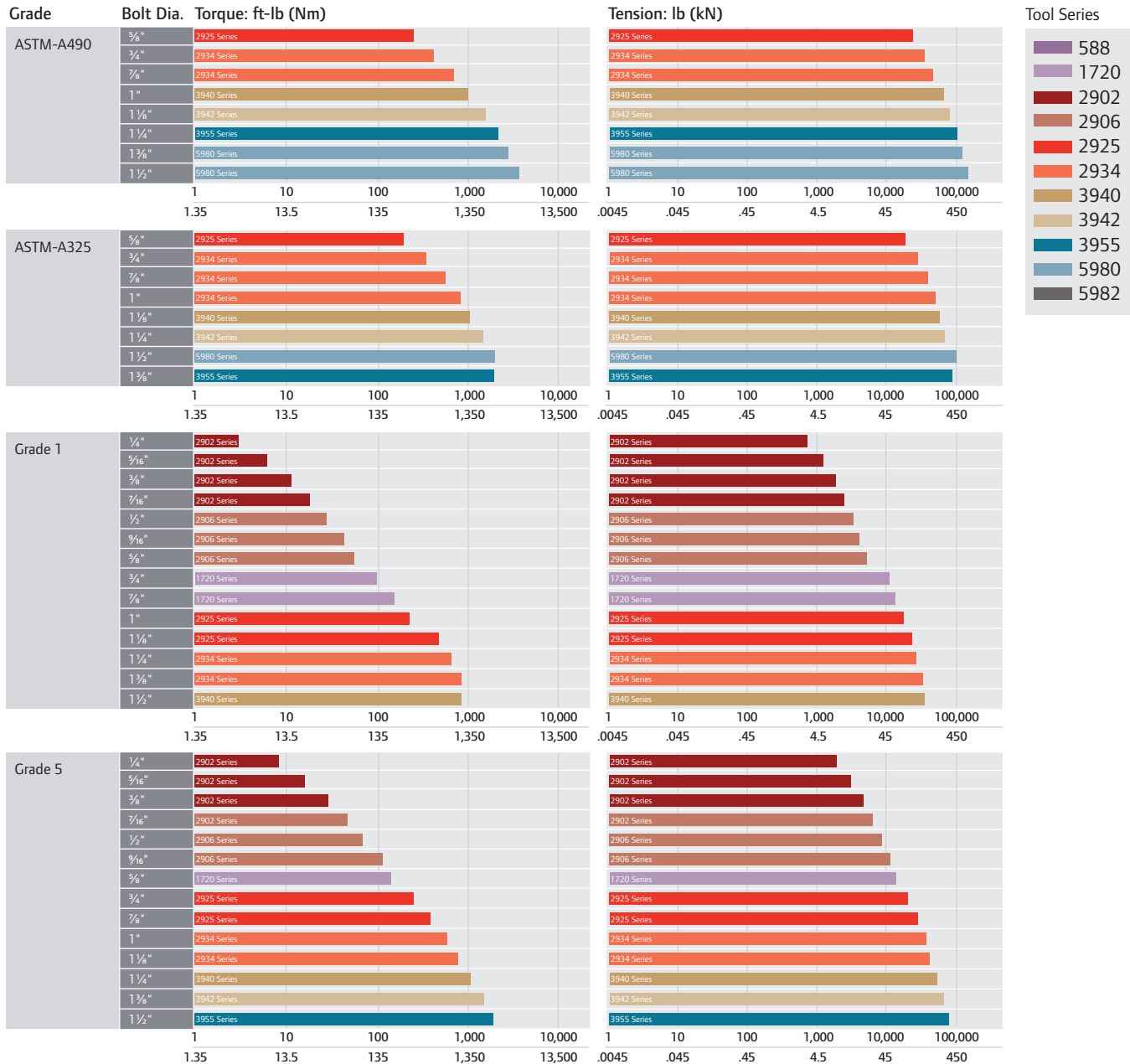

The figures used are based on 70 percent of the tension proof load of a given size and bolt grade.

For example, a Grade 5 bolt has a proof load of 94,200 psi. A 1/2" Grade 5 bolt has a tensile stress area—the cross-section at the root of the thread—of 0.1282 sq in, and an actual proof load of 12,076 lb. Seventy percent of this proof load is 8,453 lb. By looking at the chart, we find that in order to put 8,450 lb of tension on the 1/2" UNC Grade 5 bolt, we must apply 70 ft-lb of torque. To do this, we recommend the 2906 Series Impactool. Remember that 70 percent of the proof load is normally the amount of tension needed to ensure a properly tightened joint.

The appropriate torque required to achieve 70 ft-lb is based on the formula $T = kDL$, where T = torque (ft-lb), k = frictional constant = 0.2*, D = fastener diameter (ft), and L = loader tension (lb).

*The frictional constant can vary based on thread condition, lubrication, and surface conditions, and should be established through testing for critical applications. Only certain tools are shown in this chart. Compare the required torque shown with torque ranges shown in the tool specifications tables to select other suitable tools.

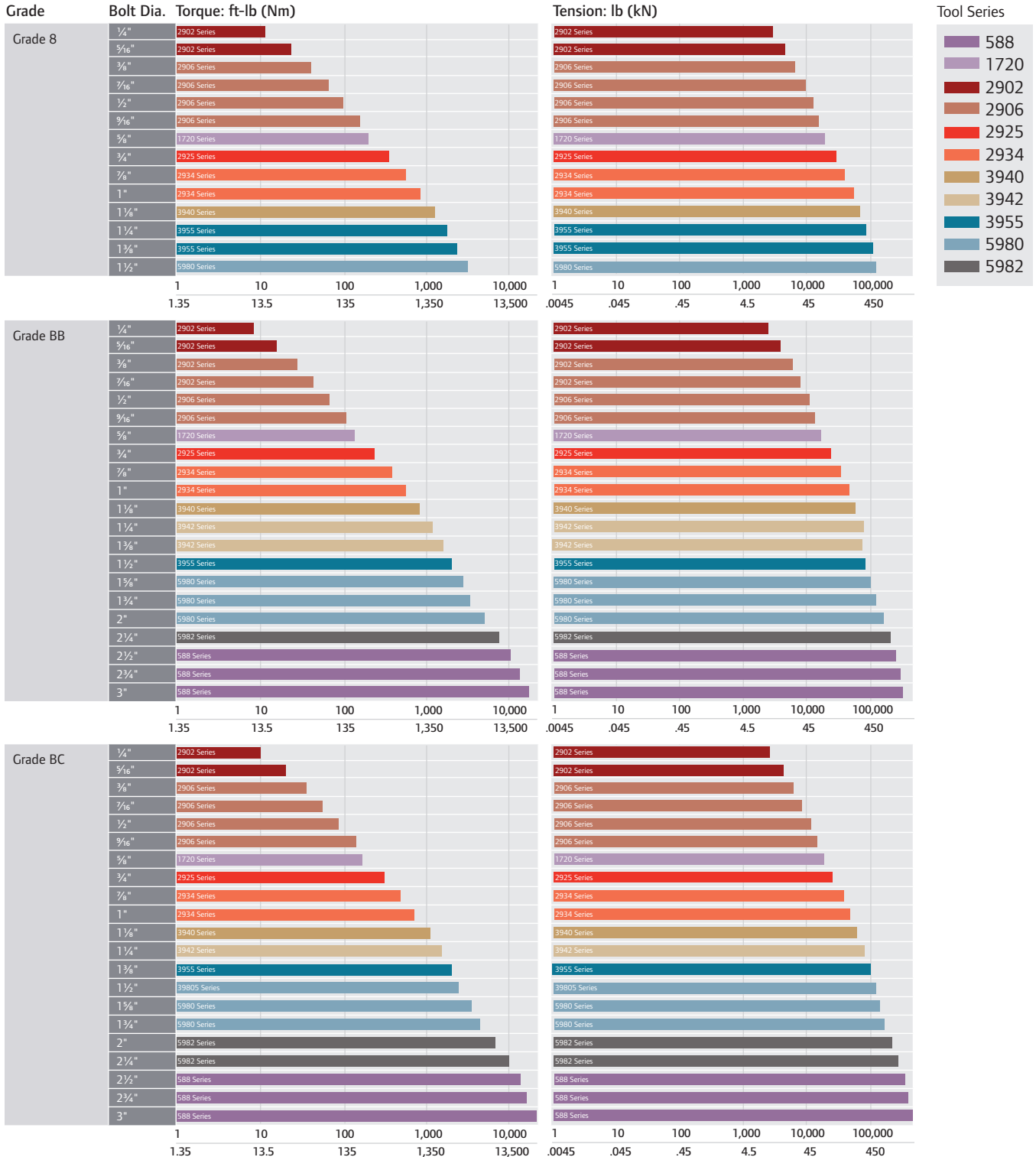

Maintenance-Duty

3/8"-1" Drives



2125PTIMAX



2235QPTIMAX



2850MAX

FEATURES

- Titanium hammer case
- Cast aluminum hammer case (2015/25 MAX)
- Composite housing
- Reverse-biased motor
- Twin hammer mechanism
- Single hammer mechanism (2015/25 MAX)
- 1/4" NPT inlet

MAINTENANCE-DUTY 2100-2200 MAX Series

Model	Description	Actuation	Details	Handle	1 min. rpm	1 min. bpm	Max ft-lbs	ft-lb (Nm)	lb (kg)	in (mm)	in (mm)	cfm (l/s)	m/s ² (K)
3/8" - 1/2"													
2115PTIMAX	3/8" Square	Trigger	Pin	Pistol	15000	1500	300 (407)	25-230 (34-312)	2.48 (1.12)	5.9 (151)	1.1 (28)	17 (481)	7.5 (1.8)
2115QPTIMAX	3/8" Square	Trigger	Pin, Quiet	Pistol	15000	1500	300 (407)	25-230 (34-312)	2.48 (1.12)	5.9 (151)	1.1 (28)	17 (481)	7.5 (1.8)
2125PTIMAX	1/2" Square	Trigger	Pin	Pistol	15000	1500	332 (450)	25-251 (34-340)	2.51 (1.14)	6.1 (155)	1.1 (28)	17 (481)	7.5 (1.8)
2135PQXPA	1/2" Square	Trigger	Pin, Quiet	Pistol	11000	1250	780 (1057)	200-900 (272-1220)	4 (1.8)	7.4 (189)	1.38 (35)	24 (680)	13.3 (NA)
2135PTIMAX	1/2" Square	Trigger	Pin	Pistol	11000	1250	780 (1057)	200-900 (272-1220)	3.95 (1.79)	7.5 (190)	1.38 (35)	24 (680)	13.3 (4.6)
2135QPTIMAX	1/2" Square	Trigger	Square, Pin	Pistol	11000	1250	780 (1057)	200-900 (272-1220)	3.95 (1.79)	7.5 (190)	1.38 (35)	24 (680)	13.3 (4.6)
1/2"													
2235PTIMAX	1/2" Square	Trigger	Pin	Pistol	8500	1220	1350 (1830)	200-900 (272-1220)	4.7 (2.1)	7.6 (193)	1.36 (30)	24 (680)	9.0 (2.8)
2235QPTIMAX	1/2" Square	Trigger	Pin, Quiet	Pistol	8500	1220	1350 (1830)	200-900 (272-1220)	4.7 (2.1)	7.6 (193)	1.36 (30)	24 (680)	9.0 (2.8)
2145QIMAX	3/4" Square	Trigger	Hog-ring, Thru-hole, Quiet	Pistol	7000	1150	1350 (1830)	200-900 (272-1220)	7.4 (3.4)	8.5 (217)	1.6 (41.5)	32 (906)	8.7 (0.8)
1"													
2175MAX	1" Square	Trigger	Thru-Hole	Pistol	4500	740	1900 (2580)	300-1600 (407-2169)	18.0 (8.2)	10.0 (254)	14.2 (402)	11.8 (3.6)	9.0 (2.8)
2850MAX	1" Square	Inside Trigger	Thru-Hole	D-Handle	5500	770	2100 (2850)	300-1600 (407-2169)	19.4 (8.8)	13.1 (334)	14.0 (397)	10.3 (1.9)	12.6 (3.6)

Find matching accessories on pages 29 – 35.

Find matching sockets on pages 29-30, FRL's on 32, balancers on 33 and service kits and hangers on 34.



Less Maintenance, More Uptime

Air tools have a simple design with fewer parts, lowering maintenance costs and making service easier. Air tools can also be rebuilt multiple times during the tools lifespan, extending the life of the tool. It all adds up to increased productivity!



Maintenance-Duty

3/4"-1" Drives



2141P



2171P

FEATURES

- Steel hammer case
- Composite housing (2141, 2141P)
- Twin hammer mechanism
- Jumbo hammer mechanism (2161, 2171P)
- 3/8" NPT inlet

MAINTENANCE-DUTY 2100 Series

Model	Description	Actuation	Details	Handle	1 min. rpm	1 min. bpm	Max ft-lbs (Nm)	ft-lb (Nm)	lb (kg)	in (mm)	in (mm)	cfm (l/s)	m/s ² (K)
3/4" - 1"													
2141P	3/4" Square	Trigger	Thru-Hole	Pistol	8000	1175	1200 (1627)	200-900 (272-1220)	7.15 (3.24)	8.2 (208)	1.84 (47)	40 (1133)	10.2 (1.4)
2161P	3/4" Square	Trigger	Thru-Hole	Pistol	6000	1025	1250 (1695)	300-1000 (407-1360)	12.14 (5.51)	8.5 (216)	1.75 (44)	46 (1303)	11.5 (3.8)
2171P	1" Square	Trigger	Thru-Hole	Pistol	6000	1025	1250 (1695)	300-1000 (407-1360)	12.32 (5.59)	8.9 (227)	1.75 (44)	46 (1303)	11.5 (3.8)

Find matching sockets on pages 30-31, FRL's on 32, balancers on 33 and service kits and hangers on 34.

1712B2



FEATURES

- Steel hammer case
- Jumbo hammer mechanism
- Pressure-feed mechanism lubrication
- Integral muffler
- 3/8" inlet

MAINTENANCE-DUTY 1700 Series

Model	Description	Actuation	Details	Handle	1 min. rpm	1 min. bpm	Max ft-lbs (Nm)	ft-lb (Nm)	lb (kg)	in (mm)	in (mm)	cfm (l/s)	m/s ² (K)
1"													
1712B2	1" Square	Inside Trigger	Thru-Hole	D-Handle	6000	800	1350 (1898)	450-1000 (610-1356)	18.25 (8.28)	11.25 (286)	2.19 (56)	47 (1331)	19.7 (3.6)

Find matching sockets on page 31, FRL's on 32, balancers on 33 and service kits and hangers on 34.

261



FEATURES

- Steel hammer case
- Jumbo hammer mechanism
- Pressure-feed mechanism lubrication
- 3/8" NPT inlet

MAINTENANCE-DUTY 261 Series

Model	Description	Actuation	Details	Handle	1 min. rpm	1 min. bpm	Max ft-lbs (Nm)	ft-lb (Nm)	lb (kg)	in (mm)	in (mm)	cfm (l/s)	m/s ² (K)
3/4"													
261	3/4" Square	Trigger	Hog-ring	Pistol	5500	1000	1200 (1627)	700-1200 (949-1627)	12.4 (5.62)	8.8 (224)	1.88 (47.8)	38 (1076)	10.4 (1.3)

Find matching sockets on page 30, FRL's on 32, balancers on 33 and service kits and hangers on 34.

Heavy-Duty

1/4"-1/2" Drives



1702P1











1702SB1

FEATURES

- Jumbo hammer mechanism
- Steel hammer case
- Pressure-fed mechanism lubrication
- 1/4" NPT inlet

HEAVY-DUTY 1702 Series

Model	Description	Actuation	Details	Handle	 rpm	 bpm	 ft-lb (Nm)	 ft-lb (Nm)	 lb (kg)	 in (mm)	 in (mm)	 cfm (l/s)	 m/s ² (K)
1/4" - 3/8"													
1702P4	1/4" Hex	Trigger	Quick Change, Sleeve	Pistol	10000	1500	125 (170)	2.19 (56)	2.75 (1.25)	5.5 (140)	1.38 (35)	15	6.5 (1.0)
1702P1	3/8" Square	Trigger	Pin	Pistol	10000	1500	125 (170)	20-100 (27-136)	2.75 (1.25)	5.5 (140)	1.38 (35)	15	6.5 (1.0)
1702SB1	3/8" Square	Lever	Pin	Straight	10000	1500	105 (142)	13-85 (18-115)	2.5 (1.12)	5.88 (149)	1.0 (25)	13	8.1 (2.2)

Find matching sockets on page 30, FRL's on 32, balancers on 33 and service kits and hangers on 34.











2902P1

FEATURES

- Steel hammer case
- Jumbo hammer mechanism (2902P1)
- Twin hammer mechanism (2906P1)
- Pressure-fed mechanism lubrication
- Integral muffler
- 1/4" NPT inlet

HEAVY-DUTY 2900 Series

Model	Description	Actuation	Details	Handle	 rpm	 bpm	 ft-lb (Nm)	 ft-lb (Nm)	 lb (kg)	 in (mm)	 in (mm)	 cfm (l/s)	 m/s ² (K)
3/8" - 1/2"													
2902P1	3/8" Square	Trigger	Pin	Pistol	10000	1500	180 (244)	20-150 (27-204)	2.5 (1.25)	5.5 (140)	1.38 (35)	15 (425)	7.6 (1.8)
2906P1	1/2" Square	Trigger	Pin	Pistol	5000	1200	500 (678)	40-350 (54-375)	6 (2.72)	6.88 (175)	1.38 (35)	15 (425)	7.6 (0.9)

Find matching sockets on pages 29-30, FRL's on 32, balancers on 33 and service kits and hangers on 34.











2705P1

FEATURES

- Jumbo hammer mechanism
- Steel hammer case
- Pressure-fed mechanism lubrication
- 1/4" NPT inlet

HEAVY-DUTY 2700 Series

Model	Description	Actuation	Details	Handle	 rpm	 bpm	 ft-lb (Nm)	 ft-lb (Nm)	 lb (kg)	 in (mm)	 in (mm)	 cfm (l/s)	 m/s ² (K ⁽²⁾)
1/2"													
2705P1	1/2" Square	Trigger	Pin	Pistol	8500	1200	400 (542)	40-250 (54-271)	5.63 (2.55)	7.3 (185)	1.38 (35)	23 (651)	6.5 (0.8)
2707P1	1/2" Square	Trigger	Pin	Pistol	8500	1300	450 (610)	40-275 (54-375)	6 (2.72)	6.75 (171)	1.38 (35)	26 (736)	8.7 (0.8)

Find matching sockets on pages 29-30, FRL's on 32, balancers on 33 and service kits and hangers on 34.

Heavy-Duty

3/4"-1" Drives



1720P1











1720B1

FEATURES

- Steel hammer case
- Jumbo hammer mechanism
- Pressure-feed mechanism lubrication
- Integral muffler
- 3/8" inlet

HEAVY-DUTY 1720 Series

Model	Description	Actuation	Details	Handle	 rpm	 bpm	 Max ft-lb (Nm)	 ft-lb (Nm)	 lb (kg)	 in (mm)	 in (mm)	 cfm (l/s)	 m/s ² (K ²)
3/4" - 1"													
1720B1	3/4" Square	Inside Trigger	Thru-Hole	D-Handle	5500	1000	1000 (1360)	200-600 (271-814)	13.9 (6.3)	11.75 (299)	1.91 (48)	40 (1132)	NA
1720P1	3/4" Square	Trigger	Thru-Hole	Pistol	5500	1000	1000 (1360)	200-600 (271-814)	12.54 (5.65)	7.63 (194)	1.91 (48)	40 (1132)	10.4 (1.3)
1720B3	1" Square	Trigger Inside	Thru-Hole	D-Handle	5500	1000	1100 (1491)	250-750 (339-1017)	14 (6.35)	11.75 (299)	1.91 (48)	40 (1132)	NA
1720P3	1" Square	Trigger	Thru-Hole	Pistol	5500	1100	1100 (1491)	250-750 (339-1017)	12.54 (5.65)	7.63 (194)	1.91 (48)	40 (1132)	13.2 (1.1)

Find matching sockets on pages 30-31, FRL's on 32, balancers on 33 and service kits and hangers on 34.

2920B9











2920B1



FEATURES

- Steel hammer case
- Twin hammer mechanism
- Pressure-fed mechanism lubrication
- Integral muffler
- 3/8" NPT inlet

HEAVY-DUTY 2920 Series

Model	Description	Actuation	Details	Handle	 rpm	 bpm	 Max ft-lb (Nm)	 ft-lb (Nm)	 lb (kg)	 in (mm)	 in (mm)	 cfm (l/s)	 m/s ² (K ²)
3/4"													
2920B1	3/4" Square	Trigger Inside	Thru-Hole	D-Handle	5000	950	1100 (1492)	250-800 (339-1085)	13.19 (5.98)	12.5 (318)	1.91 (49)	36 (1020)	19.9 (6.6)
2920B9	3/4" Square	Trigger Inside	Thru-Hole at 90°	D-Handle	5000	950	550 (746)	125-400 (170-542)	23.69 (10.75)	17.5 (445)	1.31 (33)	36 (1020)	19.9 (6.6)

Find matching sockets on page 30, FRL's on 32, balancers on 33 and service kits and hangers on 35.



Lower Your Cost of Ownership

Air tools can last for decades when serviced correctly, while electric tools last for a fraction of that time, making them an excellent investment that results in less downtime.

AIR ADVANTAGE

Heavy-Duty

1"-1-1/2" Drives



2934P2



2934B2



2940B2











2950B7

FEATURES

- Cast iron hammer case
- Bronze endplates
- Twin hammer mechanism
- Pressure-fed mechanism lubrication
- Integral muffler
- 1/2" NPT inlet

HEAVY-DUTY 2934-2940-2950 Series

Model	Description	Actuation	Details	Handle	 rpm	 bpm	 ft-lb (Nm)	 ft-lb (Nm)	 lb (kg)	 in (mm)	 in (mm)	 cfm (l/s)	 m/s ² (K ²)
1"													
2934A2	1" Square	Trigger Outside	Thru-Hole	D-Handle	6600	750	1500 (2034)	500-1100 (678-1491)	18.5 (8.39)	11.25 (286)	2.19 (56)	47 (1331)	18.8 (3.7)
2934B2	1" Square	Trigger Inside	Thru-Hole	D-Handle	6600	750	1500 (2034)	500-1100 (678-1491)	18.5 (8.39)	11.25 (286)	2.19 (56)	47 (1331)	18.8 (3.7)
2934B9	1" Square	Trigger Inside	Thru-Hole at 90°	D-Handle	5300	780	750 (1017)	250-500 (339-678)	35.75 (16.2)	18.63 (473)	1.63 (41)	47 (1331)	30.8 (10.2)
2934P2	1" Square	Trigger	Thru-Hole	Pistol	5300	825	1500 (2034)	500-1100 (678-1491)	20 (9.07)	8.63 (219)	2.19 (56)	47 (1331)	13.4 (4.7)
1" - No. 5													
2940A2	1" Square	Outside Trigger	Thru-Hole	D-Handle	5000	850	2000 (2720)	1000-1600 (1360-2170)	22 (9.98)	12.25 (311)	2.19 (56)	58 (1643)	17.8 (3.4)
2940B2	1" Square	Inside Trigger	Thru-Hole	D-Handle	5000	850	2000 (2720)	1000-1600 (1360-2170)	22 (9.98)	12.25 (311)	2.19 (56)	58 (1643)	17.8 (3.4)
2940P2	1" Square	Trigger	Thru-Hole	Pistol	3350	810	2000 (2720)	1000-1600 (1360-2170)	22.9 (10.4)	9.88 (251)	2.19 (56)	58 (1643)	18.1 (5.6)
2940A1	No. 5 Spline, Ball	Outside Trigger	Locking Mechanism	D-Handle	5000	850	2000 (2720)	1000-1600 (1360-2170)	22 (9.98)	12.25 (311)	2.19 (56)	58 (1643)	17.8 (3.4)
2940B1	No. 5 Spline, Ball	Inside Trigger	Locking Mechanism	D-Handle	5000	850	2000 (2720)	1000-1600 (1360-2170)	22 (9.98)	12.25 (311)	2.19 (56)	58 (1643)	17.8 (3.4)
1 1/2"													
2950A7	1 1/2" Square	Outside Trigger	Thru-Hole	D-Handle	3750	650	3000 (4067)	1400-1800 (1900-2440)	32.6 (14.8)	14.5 (368)	2.5 (64)	70 (1982)	18.1 (5.6)
2950B7	1 1/2" Square	Inside Trigger	Thru-Hole	D-Handle	3750	650	3000 (4067)	1400-1800 (1900-2440)	32.6 (14.8)	14.5 (368)	2.5 (64)	70 (1982)	18.1 (5.6)

Find matching sockets on page 31, FRL's on 32, balancers on 33 and service kits and hangers on 35.



Less Operator Fatigue

The simple design of an air motor significantly decreases the weight of the tool compared to tools that contain heavy electric motors. A lower weight tool results in less operator fatigue and more operator control. Our air tools have an ergonomically-focused design, allowing the operator to keep a secure grip on the tool and easily move from application to application.

AIR ADVANTAGE

Super-Duty

3/4"-No 5. Drives



2925P1Ti











2925B2Ti

FEATURES

- Titanium hammer case
- Corrode-XTM component package
- Twin hammer mechanism
- Choice of balanced or reversed bias motor
- Pressure-fed mechanism lubrication
- Integral muffler
- 3/8" NPT inlet

SUPER-DUTY 2925Ti Series

Model	Description	Actuation	Details	Handle	 rpm	 bpm	 ft-lb (Nm)	 ft-lb (Nm)	 lb (kg)	 in (mm)	 in (mm)	 cfm (l/s)	 m/s ² (K ²)
3/4"-1"													
2925P1Ti	3/4" Square	Trigger	Thru-Hole	Pistol	5200	1050	1450 (1966)	350-1100 (475-1492)	12 (5.44)	8.9 (226)	1.75 (44)	60 (1699)	10.5 (1)
2925RBP1Ti	3/4" Square	Trigger	Thru-Hole	Pistol	5200	1050	1600 (2169)	400-1400 (542-1898)	12 (5.44)	8.9 (226)	1.75 (44)	60 (1699)	10.5 (1)
2925RBP1TiEX	3/4" Square	Trigger Inside	Thru-Hole	Pistol	5200	1050	1600 (2169)	400-1400 (542-1898)	12 (5.44)	8.9 (226)	1.75 (44)	60 (1699)	10.5 (1)
2925P3Ti	1" Square	Trigger	Thru-Hole	Pistol	5200	1050	1450 (1966)	350-1100 (475-1492)	12.2 (5.54)	9.04 (230)	1.75 (44)	60 (1699)	10.5 (1)
2925B2Ti	1" Square	Trigger Inside	Thru-Hole	D-Handle	6500	900	1700 (2304)	350-1100 (475-1492)	15.2 (6.89)	13.3 (337)	1.75 (44)	60 (1699)	9.8 (1.3)
2925RB2Ti	1" Square	Trigger Inside	Thru-Hole	D-Handle	6500	900	1700 (2304)	400-1400 (542-1898)	15.2 (6.89)	13.3 (337)	1.75 (44)	60 (1699)	9.8 (1.3)
2925RBP3Ti	1" Square	Trigger	Thru-Hole	Pistol	5200	1050	1600 (2169)	400-1400 (542-1898)	12.2 (5.54)	9 (230)	1.75 (44)	60 (1699)	10.5 (1)

Find matching sockets on pages 30-31, FRL's on 32, balancers on 33 and service kits and hangers on 35.











3940B2Ti

FEATURES

- Titanium hammer case
- Bronze endplates
- Twin hammer mechanism
- Reverse bias motor
- Pressure-fed mechanism lubrication
- Integral muffler
- 1/2" NPT inlet

SUPER-DUTY 3940Ti Series

Model	Description	Actuation	Details	Handle	 rpm	 bpm	 ft-lb (Nm)	 ft-lb (Nm)	 lb (kg)	 in (mm)	 in (mm)	 cfm (l/s)	 m/s ² (K ²)
1"-No. 5													
3940A2Ti	1" Square	Outside Trigger	Thru-Hole	D-Handle	6000	800	2500 (3390)	500-1800 (680-2440)	21.2 (9.6)	13.5 (343)	2.3 (59)	75 (2124)	13.1 (1.6)
3940B2Ti	1" Square	Inside Trigger	Thru-Hole	D-Handle	6000	800	2500 (3390)	500-1800 (680-2440)	21.2 (9.6)	13.5 (343)	2.3 (59)	75 (2124)	13.1 (1.6)
3940B2TiEX	1" Square	Inside Trigger	Thru-Hole	D-Handle	6000	800	2500 (3390)	500-1800 (680-2440)	21.2 (9.6)	13.5 (343)	2.3 (59)	75 (2124)	13.1 (1.6)
3940P2Ti	1" Square	Trigger	Thru-Hole	Pistol	5300	800	2500 (3390)	500-1800 (680-2440)	20.4 (9.3)	10.1 (256)	2.3 (59)	75 (2124)	14.2 (2)
3940A1Ti	No. 5 Spline	Outside Trigger	Thru-Hole	D-Handle	6000	800	2500 (3390)	500-1800 (680-2440)	21.2 (9.6)	13.5 (343)	2.3 (59)	75 (2124)A	13.1 (1.6)
3940B1Ti	No. 5 Spline	Inside Trigger	Thru-Hole	D-Handle	6000	800	2500 (3390)	500-1800 (680-2440)	21.2 (9.6)	13.5 (343)	2.3 (59)	75 (2124)	13.1 (1.6)

Find matching sockets on page 31, FRL's on 32, balancers on 33 and service kits and hangers on 35.

Super-Duty 1"-No 5. Drives









3942B2Ti



FEATURES

- Titanium hammer case
- Bronze endplates
- Twin hammer mechanism
- Reverse bias motor
- Pressure-fed mechanism lubrication
- Integral muffler
- ½" NPT inlet

SUPER-DUTY 3942Ti Series

Model	Description	Actuation	Details	Handle	 rpm	 bpm	 ft-lb (Nm)	 ft-lb (Nm)	 lb (kg)	 in (mm)	 in (mm)	 cfm (l/s)	 m/s ² (K ²)
1" - No. 5													
3942A2Ti	1" Square	Outside Trigger	Thru-Hole	D-Handle	5000	850	3250 (4406)	1000-2100 (1356-2848)	22.6 (10.5)	14.3 (362)	2.3 (59)	95 (2690)	16.9 (4.6)
3942B2Ti	1" Square	Inside Trigger	Thru-Hole	D-Handle	5000	850	3250 (4406)	1000-2100 (1356-2848)	22.6 (10.5)	14.3 (362)	2.3 (59)	95 (2690)	16.9 (4.6)
3942B2TiEX	1" Square	Inside Trigger	Thru-Hole	D-Handle	5000	850	3250 (4406)	1000-2100 (1356-2848)	22.6 (10.5)	14.3 (362)	2.3 (59)	95 (2690)	16.9 (4.6)
3942A1Ti	No. 5 Spline	Outside Trigger	Thru-Hole	D-Handle	5000	850	3250 (4406)	1000-2100 (1356-2848)	22.6 (10.5)	14.3 (362)	2.3 (59)	95 (2690)	16.9 (4.6)
3942B1Ti	No. 5 Spline	Inside Trigger	Thru-Hole	D-Handle	5000	850	3250 (4406)	1000-2100 (1356-2848)	22.6 (10.5)	14.3 (362)	2.3 (59)	95 (2690)	16.9 (4.6)

Find matching sockets on page 31, FRL's on 32, balancers on 33 and service kits and hangers on 35.



Superior Power to Weight Ratio

Air tools consistently deliver more torque and higher RPMs making them considerably more powerful than cordless tools, and a popular choice for heavy equipment manufacturing, auto repair and other industrial settings. Your operators will finish every job quickly and effectively, saving time and money.

AIR ADVANTAGE

Super-Duty









1½"-2½" Drives



FEATURES

- Titanium hammer case
- Bronze endplates
- Twin hammer mechanism
- Reverse bias motor
- Pressure-fed mechanism lubrication
- Integral muffler
- ½" NPT inlet

SUPER-DUTY 3955Ti Series

Model	Description	Actuation	Details	Handle	 rpm	 bpm	 ft-lb (Nm)	 ft-lb (Nm)	 lb (kg)	 in (mm)	 in (mm)	 cfm (l/s)	 m/s ² (K ²)
1½" - No. 5													
3955A2Ti	1½" Square	Outside Trigger	Thru-Hole	D-Handle	2750	700	5000 (6779)	1600-4150 (2170-5630)	34.6 (15.7)	16.5 (419.1)	2.67 (68)	80 (2266)	20.8 (8.5)
3955B2Ti	1½" Square	Inside Trigger	Thru-Hole	D-Handle	2750	700	5000 (6779)	1600-4150 (2170-5630)	34.6 (15.7)	16.5 (419.1)	2.67 (68)	80 (2266)	20.8 (8.5)
3955B2TIEX	1½" Square	Inside Trigger	Thru-Hole	D-Handle	2750	700	5000 (6779)	1600-4150 (2170-5630)	34.6 (15.7)	16.5 (419.1)	2.67 (68)	80 (2266)	20.8 (8.5)
3955A1Ti	No. 5 Spline	Outside Trigger	Thru-Hole	D-Handle	2750	700	5000 (6779)	1600-4150 (2170-5630)	34.6 (15.7)	16.5 (419.1)	2.67 (68)	80 (2266)	20.8 (8.5)
3955B1Ti	No. 5 Spline	Inside Trigger	Thru-Hole	D-Handle	2750	700	5000 (6779)	1600-4150 (2170-5630)	34.6 (15.7)	16.5 (419.1)	2.67 (68)	80 (2266)	20.8 (8.5)



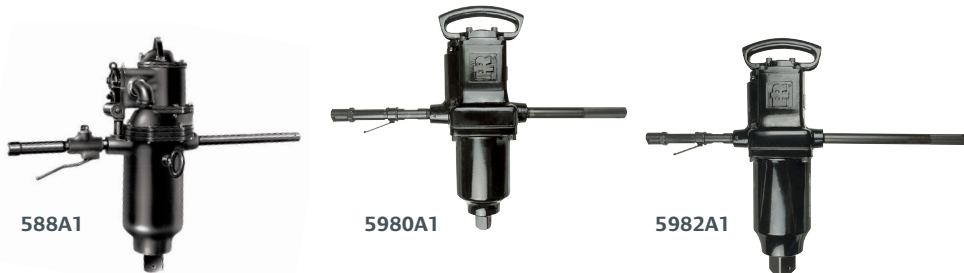





Find matching sockets on page 31, FRL's on 32, balancers on 33 and service kits and hangers on 35.



FEATURES

- Cast aluminum hammer case (5980A1, 5982A1)
- Cast iron hammer case (588A1)
- Precision ball and cam mechanism
- Built-in lubricator
- Lever throttle
- Dead handle
- Vertical and horizontal hangars

SUPER-DUTY 5000 Series

Model	Description	Actuation	Details	Handle	 rpm	 bpm	 ft-lb (Nm)	 ft-lb (Nm)	 lb (kg)	 in (mm)	 in (mm)	 cfm (l/s)	 m/s ² (K ²)
1½"-2½"													
5980A1	1½" Square	Lever	Thru-Hole	T-Handle	830	1000	10000 (13.56)	2300-5500 (3119-7460)	88 (39.9)	23 (584)	3.06 (78)	138 (3908)	20.5 (6.7)
5982A1	2½" Square	Lever	Thru-Hole	T-Handle	830	850	20000 (27120)	4000-10000 (5424-13560)	120 (54.5)	25.38 (645)	3.5 (90)	130 (3681)	20.5 (6.7)
588A1	2½" Square	Lever	Thru-Hole	T-Handle	355	550	50000 (67800)	12000-25000 (16270-33900)	215 (97.5)	26.63 (676)	4.0 (101)	155 (4389)	20.5 (6.7)

Find matching sockets on page 31, FRL's on 32, balancers on 33 and service kits and hangers on 35.

ATEX-Certified Air Impact Wrenches



Hazardous Duty Tools



ATEX Marking:

- ATEX 2014/34/EU
- Ex h IIA T6 Gb X

ISO 80079-36 Certified

Our heavy duty ATEX-certified impact wrenches are specifically designed for use in hazardous atmospheres. These ergonomically optimized tools are built with premium components to stand up to harsh environments and reduce the risk of sparks. These tools carry ATEX Ex h IIA T6 Gb X and ISO 80079-36 certification rating.

Made to Work Wherever Work Is Done

When it comes to getting the toughest jobs done, professionals around the world choose Ingersoll Rand for tools specifically designed to meet safety regulations for working in dangerous atmospheres. From petrochemical refineries to plastic manufacturers, Ingersoll Rand offers safe and productive solutions to meet the demands of our customers, because making tools that can't work where our customers work is not an option.

Safety:

- Reduces risk of arcs or sparks. Complies with stringent European safety directives (ATEX) for use in explosive atmospheres that help expedite your hot work permit process

Reliability:

- The outstanding quality of Ingersoll Rand tools and our extended maintenance intervals give you more time to get the job done. Minimize your downtime and maximize productivity

Durability:

- Premium components such as bronze end plates and titanium hammer cases help extend tool life



2925RBP1TiEX











3955B2TiEX

FEATURES

- Titanium Hammer Case
- Twin Hammer Mechanism
- Bronze Bushing
- Reverse Bias Motor
- Pressure Fed Lubrication
- Bronze Endplates

ATEX-CERTIFIED AIR IMPACT WRENCHES

Model	Description	Actuation	Details	Handle	 rpm	 bpm	 Max. ft-lbs (Nm)	 ft-lb (Nm)	 lb (kg)	 in (mm)	 in (mm)	 cfm (l/s)	 m/s ² (K ²)
¾ - 1½"													
2925RBP1TiEX	¾" Square	Trigger	Thru-Hole	Pistol	5200	1050	1600 (2169)	350-100 (475-1492)	12 (5.44)	8.9 (226)	1.75 (44)	60 (1699)	10.5 (1)
3940B2TiEX	1" Square	Inside Trigger	Thru-Hole	D-Handle	2500	800	2500 (3390)	500-1800 (680-2440)	21.2 (9.6)	13.5 (343)	2.3 (59)	64 (1812)	13.1 (1.6)
3942B2TiEX	1" Square	Inside Trigger	Thru-Hole	D-Handle	5000	850	3250 (4406)	1000-2100 (1356-2848)	22.6 (10.5)	14.3 (362)	2.3 (59)	95 (2690)	16.9 (4.6)
3955B2TiEX	1½" Square	Inside Trigger	Thru-Hole	D-Handle	2750	700	5000 (6779)	1600-4150 (2170-5630)	34.6 (15.7)	16.5 (419.1)	2.67 (68)	80 (2266)	20.8 (8.5)

Find matching sockets on pages 30-31, FRL's on 32, balancers on 33 and service kits and hangers on 35.

Cordless Impact Wrenches



Cordless for Pros

As a world leader in enhancing productivity, Ingersoll Rand is the only company offering cordless tools specifically engineered for industrial MRO tool users. Our cordless tools deliver portability with the reliability of advanced battery/charger technologies and proven Ingersoll Rand power and durability. With Ingersoll Rand you get cordless tools that work as hard as you. You can literally take them and run ... and run and run.

Cordless Impact Wrenches - Torque Ranges (ft-lb)

	Square drive	Page no.	40	60	80	100	200	400	600	800	1000	1500	2000	3000	4000	5000	6000	8000	10000		
W5133	3/8"	24	█																		
W7152	1/2"	24	█																		
W7172	3/4"	24	█																		

Cordless Convenience. Uncompromising Power.

The Ingersoll Rand IQ^{V20} Series™ of 20-volt tools are designed, built and tested to stand up to the all day, every day demands of professionals. With 20 volts of hard-hitting, long-lasting power, IQ^{V20} Series tools deliver uncompromising abilities to **Do the Job, Do it Fast, Do it Every Time.**

Accessibility:

- The compact, cordless design of every IQ^{V20} Series tool makes accessing tight spaces easier

Comfort:

- Lightweight design and small handles help minimize fatigue, making tools more ergonomic and comfortable to hold

Durability:

- Strength in every detail, including robust, metal-reinforced composite housings that protect against breakage and corrosive chemicals

One Battery Platform. Multiple Benefits.

The BL2022 high-power extended life 20-volt lithium-ion battery delivers a high-charge capacity with low internal impedance for maximum power delivery and run-time. And our innovative, multi-use BC1121 lithium-ion universal charger will make it easier and faster to have a freshly charged battery to get your work done now, not later.



High-power, extended-life 20-volt lithium-ion battery delivers high-charge capacity and low internal impedance for exceptional runtime.

Compatibility with all IQ^{V20} series power tools allows you to swap batteries and tools to get the job done efficiently every time.

Intelligent Battery Management System prevents overloading, overcharging and over-discharging for longer tool and battery life.



LED fuel gauge and audible alarm increase productivity by letting you know when your batteries are fully charged.

Versatile USB charge port on the side means you don't have to fight for an outlet with your tablet or smart phone.

Rapid Charging brings a fully depleted battery to 100% charge in about an hour.

We back all of our IQ^{V20} Series impact wrenches and batteries with an industry-leading warranty.

IQ^V Series WARRANTY

IQ^V Series includes IQ^{V20} and IQ^{V12}

3 Year Limited Warranty on Tools and Chargers	2 Year High-Capacity Battery Replacement	1 Year Tool, Battery & Charger Replacement
applies to IQ Series batteries 3.0 Ah or greater		

See IngersollRandProducts.com/cordless for official Terms & Conditions. May vary by country.

IQ^{V20} Series Impact Wrench

3/8"-3/4" Drive

Ingersoll Rand next generation compact impact wrenches deliver increased durability and a tapered front end that creates increased access. Both the 3/8" W5133 and the 1/2" W7152 feature a Chip-On-Board (COB) LED that eliminates shadows for excellent visibility. Built on over 100 years of power tool experience, these tools offer the power you want with the control you need.

Tuned impact mechanism

delivers superb nut-busting torque and MAX torque in a compact footprint

All-metal drivetrain and hammer mechanism is robust, durable and optimized for maximum power and efficiency

Variable-speed switch with electronic brake provides maximum control of the tool and increases safety—release trigger, drive stops spinning

Tough composite housing and patented steel-reinforced frame protects against aggressive fluids, chemicals and repeated drops

Powerful brushless motor delivers durability and efficiency as well as best-in-class power-to-weight ratio

Shadowless 360° LED light ring with task light mode and 4 dimmable settings

IQ^V Power Control System includes 4 modes



W7152

W5133

W5133, W7152 and W7172												
Model	Description	Details	Handle	Voltage	rpm	bpm	Max ft-lb (Nm)	ft-lb (Nm)	lb (kg)	in (mm)	in (mm)	m/s ² (K ⁽²⁾)
3/8"												
W5133	3/8" Square	Retainer Ring or Pin Retainer	Pistol	20	2100	3300	NA	2-365 (3-495)	5.29 (2.40)	7.05 (179)	1.42 (36.1)	12.6 (1.7)
1/2"												
W7152	1/2" Square	Retainer Ring	Pistol	20	1900	2450	NA	4-1000 (6-1360)	7.6 (3.4)	8.1 (207)	1.67 (42.4)	17 (3.7)
W7152P	1/2" Square	Pin Retainer	Pistol	20	1900	2450	NA	4-1000 (6-1360)	7.6 (3.4)	8.1 (207)	1.67 (42.4)	17 (3.7)
3/4"												
W7172	3/4" Square	Retainer Ring & Thru-Hole	Pistol	20	1900	2450	NA	4-1000 (6-1360)	7.8 (3.5)	8.5 (215)	1.67 (42.4)	16.6 (1.9)

Find matching sockets on pages 29-30 and balancers on 33.

Tool Flexibility

The IQ^V Power Control System includes 4 modes: max power, half power, wrench tight and hand tight. No matter the application, there's no need to switch tools. With the intuitive and familiar dial on the back of the tool, the W7152 delivers just the right amount of torque when you need it.

MODE	HAND TIGHT	WRENCH TIGHT	MID POWER	MAX POWER
* ft-lb (Nm)	2-9 (3-12)	10-24 (13-33)	230 (312)	280 (380)
	365 (495)	365 (495)	365 (495)	365 (495)
RPM	0-800	0-1600	0-2100	0-2100
BOLT SIZE	M6-M12	M10-M16	M12-M32	M16-M32
SHUT OFF	✓	✓		



Power and Safety First

Ingersoll Rand offers the only certified* Class 1, Division 2 cordless impact wrenches on the market. The W5153P-C1D2 delivers the power and durability you need in tough, hazardous environments.



W5153P-C1D2



Oil and Gas



Petrochemical



Heavy Equipment



Mining

*This tool conforms to UL standard 12.12.01-2017 Class 1, Division 2, Groups A-D, T4; and is certified to CSA Standard C22.2 No 213

QX Series™ Cordless Torque Multiplier



Next Generation Productivity

The innovative QXM Cordless Torque Multiplier will reduce your fastening time and cost, while ensuring repeatable accuracy for all torque-critical joints. Designed with a premium gearbox and an efficient, time-tested closed-loop transducer, the Torque Multiplier is world-class in quality, control and programmable configurations to maximize your productivity.

All pistol models are also available as kits or in a hazardous duty configuration.

Accuracy:

- Closed-loop transducer control at the heart of the tool delivers precise torque and accurate, traceable results

Control:

- Multi-function display lowers set up time; user-programmability reduces the number of tools that you need







Communication:

- USB or optional wireless connections provide data management, process control and the ability to adjust tool configurations against breakage and corrosive chemicals

Versatility:

- Fast programming, the freedom of cordless, pistol or angle models and HAZ TOOL C1D2 option provide flexibility



QXM Cordless Torque Multiplier										
Model	Description	Handle	 Voltage	 rpm	 ft-lb (Nm)	 lb (kg)	 in (mm)	 in (mm)	 Communication	
QXM Pistol*										
QXC2PT200NPS12	¾"	Pistol	20V	45	30-148 (40-200)	8 (3.62)	14.69 (373)	2.20 (56)	Via USB Cable Only	
QXC2PT500NPS12	¾"	Pistol	20V	18	74-369 (100-500)	8 (3.62)	14.69 (373)	2.20 (56)	Via USB Cable Only	
QXC2PT1000NPS12	¾"	Pistol	20V	9	148-738 (200-1,000)	12 (5.44)	16.50 (419)	3.14 (80)	Via USB Cable Only	
QXC2PT1350NPS16	1"	Pistol	20V	7	200-996 (270-1,350)	1 (5.44)	16.50 (419)	3.14 (80)	Via USB Cable Only	
QXC2PT2000NPS16	1"	Pistol	20V	5	295-1,475 (400-2,000)	15 (6.80)	17.80 (452)	3.14 (80)	Via USB Cable Only	
QXX2PT200NPS12	¾"	Pistol	20V	45	30-148 (40-200)	8 (3.62)	14.69 (373)	2.20 (56)	Wireless Enabled	
QXX2PT500NPS12	¾"	Pistol	20V	18	74-369 (100-500)	8 (3.62)	14.69 (373)	2.20 (56)	Wireless Enabled	
QXX2PT1000NPS12	¾"	Pistol	20V	9	148-738 (200-1,000)	12 (5.44)	16.50 (419)	3.14 (80)	Wireless Enabled	
QXX2PT1350NPS16	1"	Pistol	20V	7	200-996 (270-1,350)	1 (5.44)	16.50 (419)	3.14 (80)	Wireless Enabled	
QXX2PT2000NPS16	1"	Pistol	20V	5	295-1,475 (400-2,000)	15 (6.80)	17.80 (452)	3.14 (80)	Wireless Enabled	
QXM Angle Wrench										
QXX5A45T0180PS12	¾"	Angle	20V	110	27-132 (16-180)	11.4 (4.25)	10.40 (264)	3 (76.2)	Wireless Enabled	
QXX5A45T0270PS12	¾"	Angle	20V	77	40-200 (54-270)	11.4 (4.25)	10.40 (264)	3 (76.2)	Wireless Enabled	
QXX2A52T0396PS12	¾"	Angle	20V	21	59-291 (79-395)	9.5 (3.54)	8.50 (216)	3 (76.2)	Wireless Enabled	
QXX2A52T0594PS12	¾"	Angle	20V	14	88-438 (119-594)	10.9 (4.06)	8.50 (216)	3 (76.2)	Wireless Enabled	
QXX5A52T0880PS12	¾"	Angle	20V	23	130-650 (180-880)	12.3 (4.60)	10.40 (264)	3 (76.2)	Wireless Enabled	
QXX5A72T1080PS16	1"	Angle	20V	19	160-797 (216-1,080)	16 (5.97)	10.40 (264)	3 (76.2)	Wireless Enabled	
QXX5A72T1620PS16	1"	Angle	20V	13	239-1,195 (324-1,620)	16 (5.97)	10.40 (264)	3 (76.2)	Wireless Enabled	

*Pistol models available as kits or in C1D2 hazardous duty configuration.

Find matching sockets on pages 30-31 and balancers on 33.

Accessories



Match the Best Tools with the Best Accessories

When there's a demanding job to do, you need tools and accessories that are going to work as hard as you do. That's exactly what you get when you turn to Ingersoll Rand.

Our complete line of tool-related accessories reflects the same high performance standards you expect from Ingersoll Rand — the global leader for durable and reliable tools and equipment.

Ingersoll Rand PowerSockets®

Up to 50% Power.

Ingersoll Rand PowerSockets® are a revolutionary solution to bust through the most stubborn bolts. The patent-pending power ring design provides up to 50% more torque* with your ½" impact wrench to get REAL WORK done. The PowerSockets® eliminate the need for additional tools, providing timesaving power and versatility to increase your productivity. Built to the same standards as our professional-grade impact sockets and backed by a limited-lifetime warranty, the PowerSockets® are built to last and work as hard as you.

Patent-pending power ring design creates increased torque up to 50%* on ½" impact wrenches to tackle the toughest jobs

Less work required through increased power eliminates the need for breaker bars, cheater pipes or more expensive larger tools



Versatile configuration fits on any ½" impact wrench, reducing the need for additional tools and unwanted downtime

Compact solution that provides power in the tightest spaces, helping you access hard-to-reach spots

Available Sizes:



½" PowerSocket	
Model	Description
S64M17L-PS1	17mm
S64M18L-PS1	18mm
S64M19L-PS1	19mm
S64M21L-PS1	21mm
S64M22L-PS1	22mm
S64M24L-PS1	24mm
S64M26L-PS1	26mm
S64M27L-PS1	27mm
S64H34L-PS1	¾"
S64H78L-PS1	⅞"
S64H1516L-PS1	1⅝"

FOR USE ON:

½ inch tools

Impact Sockets

3/8"-3/4" Drives



FEATURES

- Socket set includes a plastic storage case for organization and portability
- Chrome-molybdenum steel
- Laser-etched size labeling
- Backed by a lifetime warranty

3/8"-1/2" Drive Combo Standard & Deep Socket Set

Part Number	Number of Pieces	Description	Drive Size		Socket Sizes														
			3/8"	1/2"	5/16"	3/8"	7/16"	1/2"	9/16"	5/8"	11/16"	3/4"	-	-	-	-	-	-	in
SK34C86N	86	Standard & Deep	3/8"	1/2"	9	10	11	13	14	15	17	19	-	-	-	-	-	-	mm
			1/2"	7/16"	1/2"	9/16"	5/8"	11/16"	3/4"	13/16"	3/8"	15/16"	1	1 1/16"	1 1/8"	1 1/4"	-	-	in
			1/2"	10	11	12	13	14	15	16	17	18	19	21	22	26	27	mm	
			1/2"	10	11	12	13	14	15	16	17	18	19	21	22	26	27	mm	



1/2" Drive 13 & 14 Piece SAE Impact Socket Sets

Part Number	Number of Pieces	Description	Drive Size		Socket Sizes														
			1/2"	3/4"	7/16"	1/2"	9/16"	5/8"	11/16"	3/4"	13/16"	7/8"	15/16"	1	1 1/16"	1 1/8"	1 1/4"	-	in
SK4H13N	13	Standard	1/2"	3/4"	7/16"	1/2"	9/16"	5/8"	11/16"	3/4"	13/16"	7/8"	15/16"	1	1 1/16"	1 1/8"	1 1/4"	-	in
SK4H13LN	13	Deep	1/2"	3/4"	7/16"	1/2"	9/16"	5/8"	11/16"	3/4"	13/16"	7/8"	15/16"	1	1 1/16"	1 1/8"	1 1/4"	-	in
SK4M14N	14	Standard	1/2"	3/4"	10	11	12	13	14	15	16	17	18	19	21	22	26	27	mm
SK4M14LN	14	Deep	1/2"	3/4"	10	11	12	13	14	15	16	17	18	19	21	22	26	27	mm

3/4" Drive 8 Piece SAE Impact Socket Set

Part Number	Number of Pieces	Description	Drive Size		Socket Sizes							
			3/4"	1"	1 1/16"	1 1/8"	1 1/4"	1 5/16"	1 3/8"	1 7/8"	1 1/2"	in
SK6H8LN	8	Deep	3/4"	1"	1 1/16"	1 1/8"	1 1/4"	1 5/16"	1 3/8"	1 7/8"	1 1/2"	in



Individual 1/2" Sockets

Part Number	Output Size	Description
S64M17	17 mm	Standard
S64M17L	17 mm	Deep
S64M19	19 mm	Standard
S64M19L	19 mm	Deep
S64M21	21 mm	Standard



Accessories

Part Number	Description
RR10003	3/8" Retainer Ring
RR10006	1/2" Retainer Ring
RR10008	Retainer Ring for A6FM Adapter
RR100010	3/4" Retainer Ring (up to 1" output size)
RR100034S	3/4" Retainer Ring (over 1" output size)
A6F4M	1/2" Female to 3/4" Male Adapter

Additional individual sockets (SAE and metric), socket sets and accessories are available for each drive size. See the Accessories Catalog **IRITS-0810-069**.

Impact Sockets

1"-2½" Drives



FEATURES

- Genuine OEM parts
- Chrome-molybdenum steel
- Excellent performance and durability
- Laser-etched size labeling
- Backed by a lifetime warranty

1"-2½" Drive 5 & 9 Piece SAE Impact Socket Sets

Part Number	Number of Pieces	Description	Drive Size		Socket Sizes							
			1"	1½"	1"	1¼"	1½"	1⅝"	1⅞"	2"	2½"	
SK8C5TN	5	Deep	1"	Deep Hex	19/16	1½	-	-	-	-	-	in
			1"	Deep Hex	33	-	-	-	-	-	-	mm
			1"	Deep Thin Wall Hex	11/8	1¼	-	-	-	-	-	in
SK8H9TN	9	Deep	1"	Deep Hex	19/16	7/8	15/16	1	13/16	1½	in	
			1"	Deep Thin Wall Hex	11/16	11/8	1¼	-	-	-	in	



Individual 1" Sockets			
Part Number	Output Size	Description	
S68M30L	30 mm	Deep	
S68M32	32 mm	Standard	
S68M32L	32 mm	Deep	
S68M33L	33 mm	Deep	



Accessories	
Part Number	Description
A8F6M	1" Female to ¾" Male Adapter
RR10015S	1" Retainer Ring



Individual 1½" Sockets			
Part Number	Output Size	Description	
S612M46	46 mm	Standard	
S612M55L	55 mm	Deep	



Accessories	
Part Number	Description
A12F8M	1½" Female to 1" Male Adapter
RR10025S	1½" Retainer Ring



Individual 2½" Sockets			
Part Number	Output Size	Description	
S620H3-12	3½"	Standard	
S620H3-78	3¾"	Standard	
S620M105	105 mm	Standard	



Accessories	
Part Number	Description
A20F12M	2½" Female to 1½" Male Adapter
RR10035S	2½" Retainer Ring



Individual #5 Spline Sockets			
Part Number	Output Size	Description	
S65SH1	1"	Standard	
S65SH1-12	1½"	Standard	
S65SH1-34	1¾"	Standard	

Additional individual sockets (SAE and metric), socket sets and accessories are available for each drive size. See the Accessories Catalog **IRITS-0810-069**.

Filters, Regulators and Lubricators

Filters, regulators, lubricators, and piggybacks can be combined together to form combinations. They are typically strung together in the F+R+L arrangement (three-piece combo) and F/R+L (two-piece combo) arrangement, although other configurations are also used depending on application needs. ARO®-Flo combination FRLs are easily assembled using modular spacer kits.



2000 Series					
NPT	Filter	Components Regulator	Lubricator	scfm*	Model
Manual Drain • Metal Bowl w/Sight Glass • Relieving • w/Gauge					
3/8"	F35331-410	R37331-600	L36331-110	99/(47)	C38331-810
1/2"	F35341-410	R37341-600	L36341-110	150/(71)	C38341-810
3/4"	F35351-410	R37351-600	L36351-110	171/(81)	C38351-810
Manual Drain • Polycarbonate Bowl w/ Guard • Relieving • w/Gauge					
3/8"	F35331-400	R37331-600	L36331-100	99/(47)	C38331-800
1/2"	F35341-400	R37341-600	L36341-100	150/(71)	C38341-800
3/4"	F35351-400	R37351-600	L36351-100	171/(81)	C38351-800
Auto Drain • Metal Bowl w/Sight Glass • Relieving • w/Gauge					
3/8"	F35331-411	R37331-600	L36331-110	99/(47)	C38331-811
1/2"	F35341-411	R37341-600	L36341-110	150/(71)	C38341-811
3/4"	F35351-411	R37351-600	L36351-110	171/(81)	C38351-811
Auto Drain • Polycarbonate Bowl w/Guard • Relieving • w/Gauge					
3/8"	F35331-401	R37331-600	L36331-100	99/(47)	C38331-801
1/2"	F35341-401	R37341-600	L36341-100	150/(71)	C38341-801
3/4"	F35351-401	R37351-600	L36351-100	171/(81)	C38351-801
3000 Series					
NPT	Filter	Components Regulator	Lubricator	scfm*	Model
Manual Drain • Metal Bowl w/Sight Glass • Relieving • w/Gauge					
3/4"	F35331-410	R37331-600	L36331-110	99/(47)	C38331-810
1"	F35341-410	R37341-600	L36341-110	150/(71)	C38341-810
Auto Drain • Metal Bowl w/Sight Glass • Relieving • w/Gauge					
3/4"	F35451-410	R37451-600	L36451-110	199/(94)	C38451-810
1"	F35461-410	R37461-600	L36461-110	215/(101)	C38461-810

All technical data for these models can be found at: fluids.ingersollrand.com

Spring Balancers

Experience the effect of tool float with our spring balancers. This “gravity-free” effect on all models allows users to move tools with minimal effort along cable travel.

Medium-Duty Short Cable Balancers

- Rugged construction, cast aluminum body
- Stainless-steel cable
- Adjustable capacity
- Safety device against load dropping due to the spring breakage (>3 kg); not available on model BMDS-2
- Adjustable stroke limiting device
- Cable guide in anti-friction material
- Upper suspension shackle included on balancer for ease of installation



BMD Series			
Model	lb (kg)	SWL lb (kg)	ft (m)
BMDS-2	2.2 – 5.5 (1 – 2.5)	4.4 (2)	6.5' (2000)
BMDS-4	4.4 – 8.8 (2 – 4)	4.4 (2)	6.5' (2000)
BMDS-6	8.8 – 13.2 (4 – 6)	5.1 (2.3)	6.5' (2000)
BMDS-8	13.2 – 17.6 (6 – 8)	5.5 (2.5)	6.5' (2000)

Medium-Duty Long Cable Balancers

- Rugged construction, cast aluminum body
- Stainless-steel cable
- Adjustable capacity
- Safety device against load dropping due to the spring breakage (>3 kg)
- Adjustable stroke limiting device
- Cable guide in anti-friction material
- Upper suspension shackle included on balancer for ease of installation



BMDL Series			
Model	lb (kg)	SWL lb (kg)	ft (m)
BMDLN-4	4.4 – 8.8 (2 – 4)	6.4 (2.9)	8.2' (2500)
BMDLN-6	8.8 – 13.2 (4 – 6)	7.1 (3.2)	8.2' (2500)
BMDLN-8	13.2 – 17.6 (6 – 8)	7.7 (3.5)	8.2' (2500)
BMDLN-10	17.6 – 22 (8 – 10)	8.2 (3.7)	8.2' (2500)
BMDLN-12	22 – 30 (10 – 13.6)	8.8 (4)	8.2' (2500)

Intermediate-duty Balancers

- Safety device prevents load dropping due to spring breakage
- Anti-friction cable guide
- Adjustable stroke limiting device
- Upper rotary suspension
- Safety hook
- Auxiliary safety suspension



Intermediate-Duty Balancers			
Model	lb (kg)	SWL lb (kg)	ft (m)
BIDS-7	8.8 – 15.4 (4 – 7)	5.0 (2.26)	6.5' (2)
BIDS-10	15.4 – 22 (7 – 10)	5.5 (2.49)	6.5' (2)
BIDS-14	22 – 30.8 (10 – 14)	5.5 (2.49)	6.5' (2)
BIDS-18	30.8 – 39.6 (14 – 18)	6.5 (2.95)	6.5' (2)
BIDS-22	39.6 – 48.4 (18 – 22)	6.5 (2.95)	6.5' (2)
BIDS-26	48.4 – 55 (22 – 25)	6.5 (2.95)	6.5' (2)

Heavy-duty Balancers

- Safety device prevents load-dropping due to spring breakage
- Upper suspension with rotary safety hook
- Precision guided cable winding prevents jamming
- Anti-friction cable guide
- Manual locking device for instant clamping or release
- Worm screw capacity adjustment
- Spring drum assembly
- Floor controlled locking device available (BIL-7343)



Heavy-Duty Balancers			
Model	lb (kg)	SWL lb (kg)	ft (m)
BHD-15	22 – 33 (10 – 15)	22.7 (10.3)	6.5' (2)
BHD-20	33 – 44 (15 – 20)	23.4 (10.6)	6.5' (2)
BHD-25	44 – 55 (20 – 25)	24.7 (11.2)	6.5' (2)
BHD-30	55 – 66 (25 – 30)	25.4 (11.5)	6.5' (2)
BHD-35	66 – 77 (30 – 35)	26.0 (11.8)	6.5' (2)
BHD-45	77 – 99 (35 – 45)	27.3 (12.4)	6.5' (2)
BHD-55	99 – 121 (45 – 55)	27.6 (12.5)	6.5' (2)
BHD-65	121 – 143 (55 – 65)	30.0 (13.6)	6.5' (2)

Impact Service Kits and Hangers

Keep your tools performing at an optimal level with our genuine OEM service kits and replacement parts.



2115/2125 MAX Series

Part Number	Description
2115-TK2	Tune-Up Kit
2115-THK2	Hammer Kit

2135 MAX Series

Part Number	Description
2135-TK2	Tune-Up Kit
2135-THK1	Hammer Kit
2135PTi-THK1	Pin Anvil Hammer Kit

1702 Series

Part Number	Description
1702SB-TK2	Tune-Up Kit, 1702SB1
1702P-TK2	Tune-Up Kit, 1702P1
1702-A926-4	¼" Hex Quick Change Anvil
2U-A925-4	Quick Change Chuck for ¼" Hex Shank
1702-A926-7	⅞" Hex Quick Change Anvil
502-A925-7	Quick Change Chuck for ⅞" Hex Shank
1901-365	Vertical Hanger
1901-366	Horizontal Hanger
2U-215	Socket Adapter (⅜" to ½")

2900 Series

Part Number	Description
1702P-TK2	Tune-Up Kit, 2902P1
904-366	Horizontal Hanger, 2906P1
705-A926-7	Quick Change Chuck for ⅞" Hex Shank, 2906P1
2908-365	Vertical Hanger, 2906P1

2700 Series

Part Number	Description
2705-TK3	Tune-Up Kit
2707-TK2	Tune-Up Kit
2706-366	Horizontal Hanger, 2707P1



2920 Series

Part Number	Description
2920B-TK2	Tune-Up Kit
2920P-TK2	Tune-Up Kit
2910B-A926-10	Quick Change Anvil
2910-A526	#4 Spline Drive Anvil

2925 Series

Part Number	Description
2925B-TK2	Tune-Up Kit
2910-A526	#4 Spline Drive Anvil
2161-366	Horizontal Hanger
2925-TK2	Tune-Up Kit

2940 Series

Part Number	Description
2940-TK3	Tune-Up Kit

3940 Series

Part Number	Description
3940-TK1	Tune-Up Kit
3942-TK1	Tune-Up Kit

3955 Series

Part Number	Description
3955-TK1	Tune-Up Kit

2934 Series

Part Number	Description
2934-TK3	Tune-Up Kit



[ingersollrand.com](https://www.ingersollrand.com)

Ingersoll Rand (NYSE:IR) inspires progress through unleashing the potential in people and technologies to advance the quality of life. Our people work together to enhance and increase industrial productivity and efficiency.